

Parasol™ Cellular Shade

Standard Rectangular-Top Down-Top Down/Bottom-Up Installation and Care Instructions

Thank you for choosing Parasol™ Cellular Shades. With proper installation and care, your new Parasol shades will provide many years of beauty and performance.

Tools Needed

Measuring Tape	Phillips Screwdriver
Power Drill and Bits	Scissors
Long Flat blade Screwdriver	

In addition to the tools, you may need a supply of fasteners to attach the shade mounting hardware. Sheet metal screws will work with both wood and aluminum. Wall anchors or expansion bolts are recommended for non-solid surfaces such as drywall or lath and plaster.

The mounting hardware you received with your Parasol shades was specified at the time the shades were ordered, based upon your installation needs. The hardware may include:

Installation Brackets

Specialty End Mount Brackets

Extension Brackets

Swivel Brackets

Spacer Blocks

Hold Down
Extension Bracket

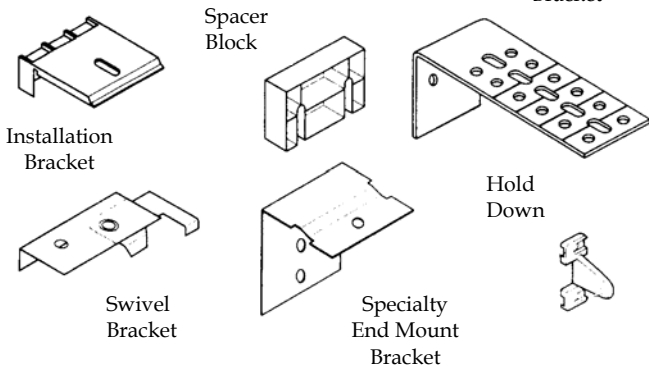

Installation Brackets are attached either inside or outside the window casement, depending upon whether the shade was ordered inside or outside mount. On outside mounts, spacer blocks or extension brackets can be used with installation brackets to allow the shade to clear obstructions. Optional swivel brackets can be used to inside mount shades within shallow window casements. Specialty end mount brackets are required when the shade's headrail must span an open space, such as under an arch. Hold down brackets are optional and prevent the bottom of the shade from swaying.

Your Parasol shade installation is organized into three simple steps. Before you begin, make sure you have all the tools and hardware you need to do the job correctly. Please read these instructions all the way through to acquaint you with the installation procedure.

1. ATTACH THE INSTALLATION BRACKET BRACKET SPACING

Spacing of standard installation brackets is the same for both inside and outside mount. Two brackets are positioned on the mounting surface so that their centerline will be 2 ¼" in from the ends of the shade. If more than two brackets are required (see chart), additional brackets are spaced evenly between the two end brackets. Measure and mark all bracket centerlines.

Note: When swivel brackets are used, measure 3" in from the ends of the shade and position a bracket screw hole at each end of those locations. When specialty end mount brackets are used, the brackets are attached to the sides of the opening at each end of the headrail.

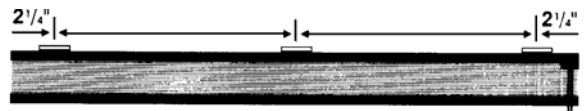

Shade Width	Brackets
Up to 31"	2
31" to 79"	3
79" to 127"	4
127" to 174"	5

INSIDE MOUNT APPLICATIONS

With inside mount applications, one mounting screw is used to attach the top of each installation bracket to the top sill of the window opening. Locate the screws on the centerlines you marked and position the brackets so that their front edges are aligned.

To attach the brackets, the flat surface of the sill must be at least 1" deep. To fully recess the shade, the flat surface must be at least 1 ½" deep for 3/8" pleat sizes, or 2 ¼" deep for ¾" pleat sizes and double cell sizes. Add to these minimums the dimensions of any obstruction to the shade movement, such as a window crank or handle.

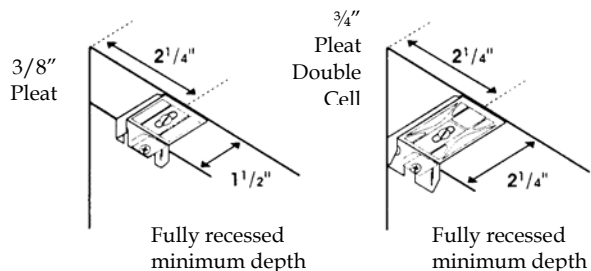

SWIVEL BRACKETS

Swivel brackets require less mounting depth than standard installation brackets. Bracket attachment requires a solid mounting only ½" deep for 3/8" pleat sizes, or 2" deep for ¾" pleat sizes and double cell styles. Add to these minimum depths the dimension of

any obstruction the shade movements, such as a window crank or handle. Swivel brackets can be used on inside mount applications only. A #6 x 1" Phillips pan head screw is recommended for use with the swivel bracket.

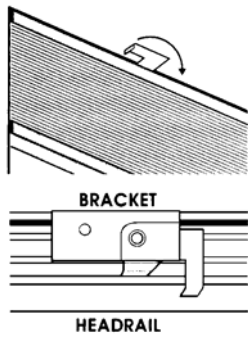

When mounting swivel brackets, locate the bracket screw holes at the positions you marked. Only one screw is needed to attach each swivel bracket. On the bracket for 3/8" pleat sizes, the single screw hole is offset from center. On the bracket for 3/4" pleat sizes and double cell styles, there are two screw holes offset from center.

Use the front hole if a mounting depth of at least 1" is available. Use the rear hole only if the mounting depth is between 1/2" and 1". **Caution:** Do not attach a screw through the swivel eyelet on the brackets.

OUTSIDE MOUNT APPLICATIONS

Mount the ends of the installation brackets on a flat vertical surface at least 5/8" high for 3/8" pleat sizes or at least 1" high for 3/4" pleat sizes and double cell styles. Two screws are used to attach each bracket. Center the brackets on the centerlines you marked and attach them with the appropriate fasteners. The tops of the installation brackets should be perfectly horizontal and aligned at the same height.

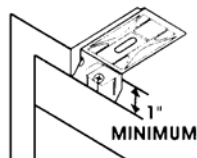
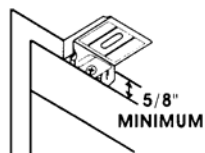

SPACER BLOCKS

Spacer blocks are used to project the installation bracket away from the mounting surface when additional clearance is needed. Each spacer block increases clearance by 1/2".

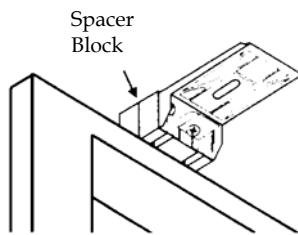

Use a maximum of three blocks per bracket, with the solid sides facing the mounting surface. Check to be sure your mounting screws are long enough for secure installation.

EXTENSION BRACKETS

Extension brackets can project the installation bracket up to 2 1/2" from the mounting surface. Position the brackets on the centerlines you marked and use two screws to attach them. Be sure to align the tops of the brackets on the same level.

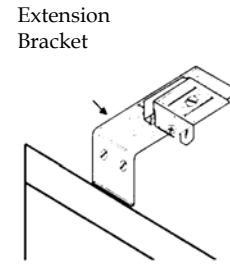

Connect the installation brackets with the machine screw and speed nut which are included with each extension bracket. Be sure to use the same hole on all the extension brackets so that each installation bracket projects the same distance from the mounting surface.

SPECIALTY END MOUNT BRACKETS

Specialty end mount brackets are used when the shade's headrail must span an open space and other mounting methods will not work. End mount brackets fit into the small grooves on the top of the headrail. Pull the cordlock out about 1/2" to insert the bracket into the grooves. On the other end of the rail, remove the end cap temporarily to install the bracket. If an arch shade shares the headrail with a standard shade, carefully insert the brackets under the arch fabric.

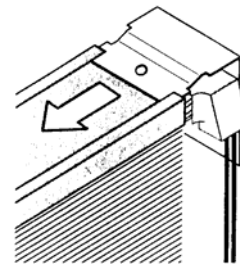

After inserting the brackets, hold the shade assembly in the window opening and mark where to drill holes for the mounting bracket screws. Use a level to make sure the headrail is perfectly horizontal. After marking and drilling the mounting screw holes, again position the shade assembly in the window opening. Gently pull the fabric forward to install the mounting screws. Be very careful not to damage or wrinkle the fabric during the installation process.

To fully recess the shade, the window opening must be 1 1/4" deep for 3/8" pleat sizes, 1 7/8" for 3/4" pleat sizes and double cell styles.

2. INSTALL THE SHADE ASSEMBLY STANDARD INSTALLATION BRACKETS

Unwind the cord from around the shade assembly and let it hang. With the cordlock facing the room side, slip the headrail into the installation brackets. The front lips on the brackets fit into the front groove on the top of the rail.

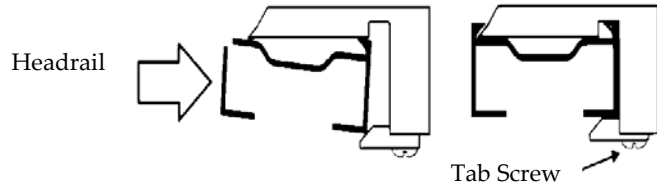

Push on the rail until it snaps into place. Then, after making sure that the fabric is not trapped between the headrail and the tabs on the installation bracket, use a screwdriver to tighten the tab screw on each bracket until it is just snug. Do not over tighten.

SWIVEL BRACKETS

With the moveable tabs on the brackets positioned outward, lift the shade into position so that the headrail is up against the back and top of the brackets. Be sure the cord is hanging freely and the front (colored) side of the fabric is facing the room side. When the shade is properly positioned, lock the headrail in place by rotating the moveable tabs to the right. Check that the shade is tightly secured at all bracket locations.

3. ADJUST THE SHADE VERIFY SHADE LENGTH

- Raise and lower the shade several times.
- If the length is incorrect or the bottom rail is not level, use the following steps to correct.

SHADE LENGTH ADJUSTMENT

Shade height and adjustments to the bottom rail can be made by adjusting the cord on the underside of the bottom rail.

- Locate the ferrule which is seated in a pocket on the bottom rail.
- Remove the ferrule by pulling on the excess cord. If the cord has been trimmed, use needlenose pliers to access it.

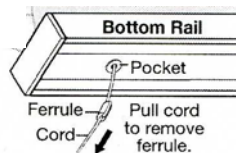

- To shorten the cord, hold the cord tight under the ferrule. Then slide the ferrule up toward the pocket.
- To lengthen the cord, hold the cord tight under the ferrule. Then slide the ferrule down.
- After adjusting, place the ferrule fully back into the pocket.
- Once you are certain of the final adjustments, trim the cord flush with the ferrule and bottom rail.

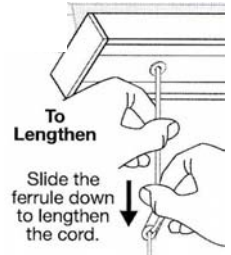
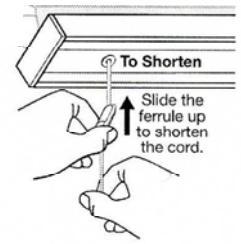

TASSEL CORD LENGTH

The tassel cord length is usually $\frac{2}{3}$ the length of the fully closed shade. To shorten the tassel cord, slide the tassel up the cord to the desired location and knot the cord. Trim the excess cord below the knot.

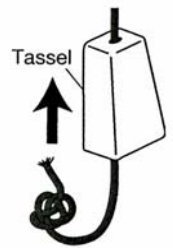

OPTIONAL HOLD DOWN BRACKETS

With the shade at its full drop, place the pins on the hold down brackets into the bottom rail end caps and mark mounting hole locations. Attach the hold down brackets with one screw through the side hole or two screws through the end holes. Be sure both bracket pins are aligned and level.

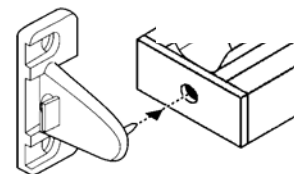

OPERATION AND CARE

OPERATION

Keep the cord close to the plane of the fabric when operating the shade. For best results, do not pull the cord away from the shade more than 15°. To disengage the locking mechanism, move the cord toward the center of the shade approximately 30° from the vertical position. Raise or lower the shade while holding the cord at this angle. To engage the locking mechanism, return the cord to the vertical position.

Note: Standard and Top Down shades have one operating cord. Top Down/Bottom Up and Day/Nighter shades have two operating cords. 2-on-1 Shades will have two cords, left shade on the left side and right shade on the right side.

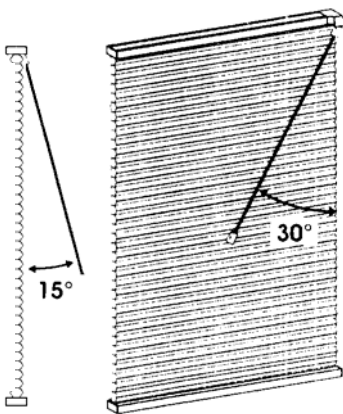

WARNING: Young children can become entangled and strangle in cords. Keep all cords out of the reach of children. Lafayette provides cord cleats and we recommend their use.



CHILD SAFETY

WARNING: keeps cords out of the reach of children. There are three basic ways to implement this essential precaution:

1. Cord Cleats

Attach two cord cleats 6" to 12" apart at the height where they will be out of the reach of children. Be sure the cleats are firmly secured. Mount the fasteners into studs, where possible, or use wall anchors when mounting into drywall. When planning the mounting height, take into account that a child may stand on a baby crib or other furniture in an attempt to reach the cords. Once the cleats are attached, simply wrap the excess cord around them after each use of the shade.

2. Cord Clip

Clip the cord to itself using a cord clip or other clamping device.

3. Tie

Wrap or tie the cord to itself.

CARE AND CLEANING

Because the Parasol fabric is anti-static, it requires very little cleaning. A light sweep with your vacuum cleaner brush attachment is all that is needed to keep it dust-free. For a more thorough cleaning, the entire shade assembly may be gently wiped with a soft, damp cloth using lukewarm water. Take special care when handling opaque fabrics to avoid creasing and **do not** immerse in water. Professional ultrasonic cleaning is another option except for shades made with opaque fabrics. Only mild cleaning solutions should be used.

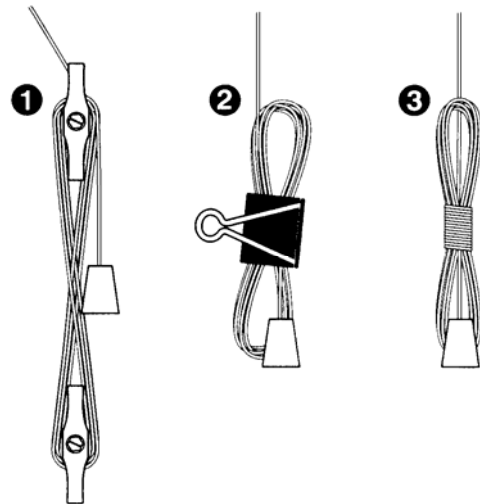

 **LAFAYETTE**
INTERIOR FASHIONS™
Beautiful Windows and More

www.lafvb.com